

The use of surface-active additives in electrochemical machining electrolytes

J. BANNARD

Department of Metallurgy and Materials Science, University of Nottingham

Received 23 May 1973

An investigation of the effect of the addition of certain 'surface-active' materials to electrolytes used in electrochemical machining was undertaken. Concentrations of only a few parts-per-million of additive affected the flow rates of the electrolyte, the settling rates of the reaction products and the dissolution of the anode. It was found that electropolishing of Fe in NaCl solution could be brought about although dissolution efficiency was reduced. The additives, however, were found to mechanically degrade under high turbulence; a dis-association mechanism for the degradation is suggested.

1. Introduction

Electrochemical machining (ECM) is a method of high-rate removal of metal where the workpiece is made the anode in an electrolytic cell. Current is passed across a narrow gap (< 1 mm) between the electrodes through which electrolyte is pumped at high rates. A high flow rate is important [1] in ECM in order to allow the high rates of metal dissolution, to prevent boiling of the electrolyte and to sweep away the reaction products. One of the main effects of the flow is to thin the diffusion layer adjacent to the dissolving metal surface which in turn limits any diffusion control of the dissolution process. Commercially a considerable amount of energy is expended in the pumping of electrolytes and any cut in pumping costs would be a welcomed advance. This paper is part of an overall study of the parameters that affect the efficiency of anodic dissolution and of the effect of additives, with a view to improving the economics of the ECM process. In the field of electroplating, the use of surface-active additives is extensive although their action is not widely understood [2]. In electropolishing, or machining they have not been extensively used.

The first stage of the present work was to look at the effect of additions of surface-active materials on the time required to pump a fixed

amount of electrolyte through a simulated electrochemical machining rig. It was thought that the fluidity of the electrolyte could be increased in two ways. The first and probably the most important manner is to decrease the shear viscosity; the materials used readily adsorb and were thought to significantly decrease the surface tension. The second way to increase the fluidity is to decrease the bulk viscosity of the electrolyte, and to this end dimethyl sulphoxide was used as a 'diluent' for the electrolyte.

The surface active materials used include polyethylene oxide ('Polyox 30') [3], sodium stearate, polyethylene glycol and a number of 'Decapols'. The 'A' series are acrylamide/acrylic acid polymers which have been hydrolysed to varying degrees by sodium hydroxide. The degree of hydrolysis that is the anionic character, increases with increase in number. The 'C' series are polymers of acrylamide and quaternary ammonium compounds and are cationic. The D610 is also cationic and the N100 is approximately neutral (very slightly anionic). They are commercially available flocculants.*

The effect of some surface-active materials on drag in liquids has been studied [4, 5] and it was concluded that drag reduction occurred only under turbulent flow conditions.

* Fospur Ltd., Alfreton, Derbyshire.

The second stage of the work involved a study of the effect of some of these additives on the flocculation time of product materials from electrochemical machining. These materials, for example ferric hydroxide, are frequently in the form of a fine gelatinous suspension which settles out only very slowly and which can be centrifuged only at great expense.

In the third stage of the work some polarization studies were made to see if the additives used had any effect on the electrochemistry of the dissolution processes. This was augmented by the EC machining of some specimens, the surfaces of which were examined using a scanning electron microscope.

2. The effect of additives on the flow rate of 15% NaCl solution (w/w)

2.1. Experimental

A flow rig was constructed, Fig. 1, consisting of a

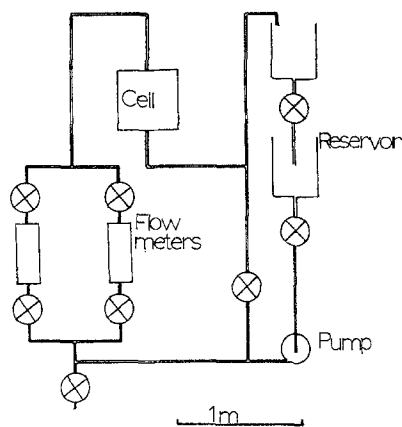

Fig. 1. Apparatus for measuring pumping times.

centrifugal pump, flow meters, a constriction in the form of an electrochemical cell and reservoirs, interconnected by 12 mm i.d. glass pipe and so constructed as to ensure turbulent flow (Reynolds number ~ 2000). The time taken to pump a fixed amount of electrolyte (20 l) from one reservoir to the other was recorded. The additives were dissolved by pumping the system for about 1 h. The temperature of the electrolyte was that of the laboratory, i.e. $20 \pm 2^\circ\text{C}$. After the study of each addition, the rig was thoroughly flushed

out and the apparatus re-standardized with the pure electrolyte.

A simple viscometer was constructed, Fig. 2,

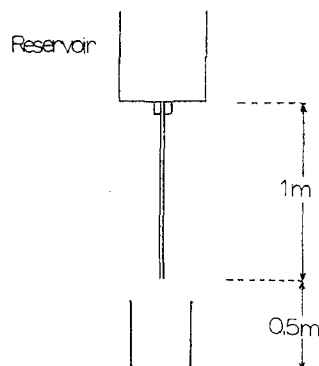

Fig. 2. Apparatus for measuring fall times.

consisting of a length of 3 mm i.d. glass tube leading from the bottom of a reservoir, the position of which was held rigid relative to the base of the receiving beaker. The time required for the free fall of a fixed amount (5 l) of electrolyte was recorded. The additives were dissolved in the electrolyte by gently agitating. The temperature of the experiments was again $20 \pm 2^\circ\text{C}$.

2.2. Results

2.2.1. Pumping times. The consistency of the measured flow times was determined by pumping pure water. The mean pumping time was 109 s with a standard deviation of less than 3 s. The effect of additions to water of Polyox 30 up to a concentration of 100 p.p.m. on the pumping time was found to be less than 5%. This is in agreement with the findings shown in Table 1 where the effects of additives on the pumping times of 15% NaCl electrolyte are given. In no case is an improvement of more than a few per cent observed.

2.2.2. Fall times. The pure 15% NaCl electrolyte (5 l) took 578 ± 1 s to flow from the reservoir. The measured times of fall with the surfactants added depended considerably on the number of the determination and the reproducibility was poorer than for the pure electrolyte. The poorer reproducibility probably arose because of un-

Table 1. Change in flow time (%) compared with 15% NaCl solution

	Concentration (p.p.m.)										
	1	2	5	10	20	50	100	500	1000	10 000	50 000
Polyox 30	0	-1	-2	-3		-5	-6				
Decapol A30	-1	-1	-2	-4		-10					
Decapol A45						-4	-4				
Decapol C300	-1	-1	-1	-3	-4	-4					
Decapol N100	-1			-2			-2				
P.e.g. 1000	0			-1		-3	-4	-3	-3		
Sodium stearate	-1			-2			-3				
Dimethyl sulphoxide				-1			-2		-3	0	+1

certainty about whether the additive had completely dissolved. The ageing effect was found to be due to mechanical agitation. Experiments carried out with the receiving beaker lifted, so that the delivery tube was kept below the liquid surface, prolonged the fall times due to the shorter fall but also considerably reduced the ageing effect. Experiments carried out using a stirrer to agitate the solution for varying periods of time also aged the solution. These stirring experiments were carried out both in the presence and in the absence of oxygen; oxidation was not occurring. Solutions stood without stirring were not aged, but a solution with e.g. 5 p.p.m. Decapol C300 addition would give the fall times appropriate to pure NaCl solution after 2 h of stirring.

The ageing effect also depended upon the amount of additive used. If large amounts of surfactant were used the fall times would decrease with successive determinations to eventually reach a minimum, thereafter increasing asymptotically back to the figure appropriate to pure electrolyte. These effects are shown in Figs. 3 and 4. It is seen from Fig. 4 that even for additions as low as 10 p.p.m., the results for the N100 and A33 Decapols go through a minimum.

The effect of concentration of additive on the fall time is displayed in Fig. 5. The apparatus was washed out and a fresh solution used after each addition. In each case the time recorded is that time for the initial fall.

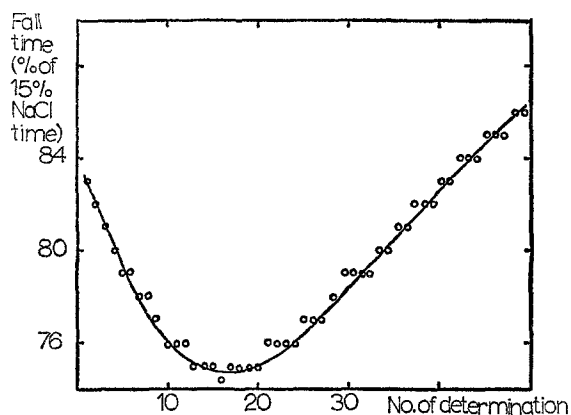

Fig. 3. The effect of agitation on the fall time for a 50 p.p.m. Decapol C300 solution.

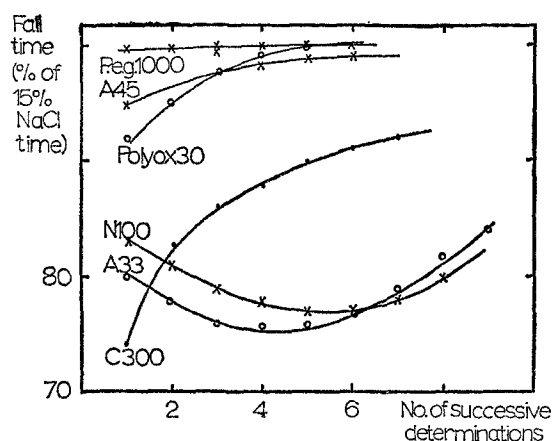

Fig. 4. The effect of agitation on fall time for solutions with 10 p.p.m. additive.

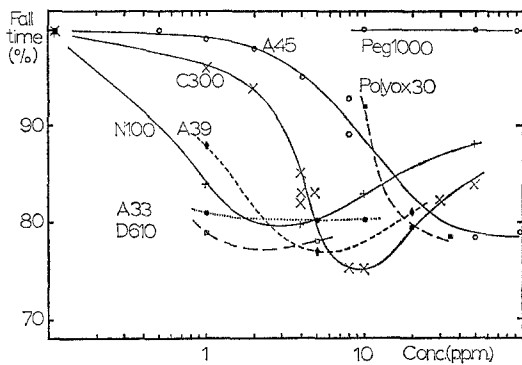

Fig. 5. Effect on initial fall times of material and concentration.

2.3. Discussion

The results presented here suggest that no significant drop in pumping power will be brought about by simply adding surface-active materials to the re-cycled electrolyte because the additives rapidly degrade when pumped. It might be possible to arrange for a bleed to continually introduce additive to the flow system, but this would present problems of build-up in the system. If the added materials are used in the flow rig, two factors must be considered. The first is the effect on pumping efficiency of the change in shear viscosity of the fluid; for the pump speeds used this was regarded as negligible. The second point, the reduction in effectiveness of the additive in a very short period of time, was regarded as significant. Surface active materials are invariably long-chain molecules and mechanical degradation appears to occur, a conclusion reached from the results presented in Figs. 3 and 4. However, it is also apparent from Fig. 3 that the activity of the additive reaches a maximum only after a certain amount of degradation has occurred, suggesting the existence of a critical concentration. This is supported by the data in Fig. 5; an association, or viscosity increase, occurred at concentrations of additive about 10 or 100 p.p.m., depending upon the material, which in the course of breakdown went through a maximum in effect before declining. All the Decapols as well as the Polyox were effective in reducing the initial flow times but all degraded rapidly. The polyethylene glycol was ineffective in reducing flow times. The simplicity of design

and low flow rates in the free-fall apparatus suggested that the flow would be laminar, and if this is so then the suggestion by Gadd [5] that drag reduction 'only occurs under turbulent flow and is associated with the anomalous behaviour of rapidly-deformed fluid particles', cannot hold. Surface adsorption effects are probably more important.

3. The effect of additives on the flocculation rate from an ECM electrolyte

3.1. Experimental

A study was made of the effect of various surface-active materials on the settling times of suspensions in electrochemical machining electrolytes. Two different electrolytes were used: electrolyte 1 was a 15% NaNO_3 solution and electrolyte 2 was a 15% NaCl solution. Both had been used commercially to machine a variety of metals and alloys including Cr, Ni-Mo, steels, etc. The main constituent of the suspended solids was thought to be hydrated ferric oxide. The electrolytes were thoroughly mixed and transferred to measuring cylinders. The test additives, dissolved in a standard volume of water, were quickly mixed with the ECM electrolytes, and the time recorded for the upper meniscus of the precipitate to pass the half-volume mark. A control experiment with a water-only addition was carried out each time.

3.2. Results

A typical time for the control sample to separate out to the half-volume mark was 60 min. With the polymer added, this time could be reduced to as low as <20 s. The results are presented in Fig. 6 as a percentage of the time of the control experiments for a variety of additives and for a variety of concentrations, each concentration representing a separate experiment. For reasons of clarity, the experimental points were mainly left out of Fig. 6. Experiments showed that on degrading, the polymers became less effective as flocculants. This is demonstrated in Table 2 which shows the different flocculating capacities of solutions of Decapol A33 added to electrolyte 2 to a concentration of 10 p.p.m. after the sur-

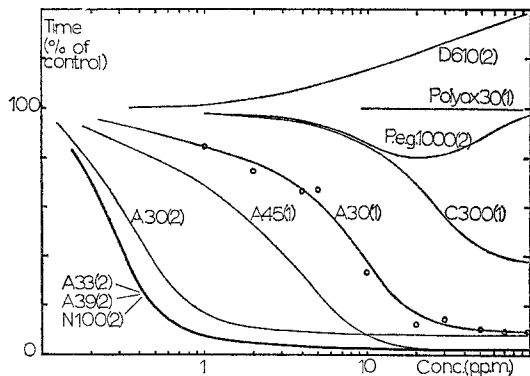

Fig. 6. Effect of concentration of additive on the flocculation times. (Figures in parentheses refer to the electrolyte.)

4. The effect of additives on the anodic dissolution of iron

4.1. Experimental

From the foregone experiments it was decided that the A33 polymer might be a successful additive to use in ECM electrolytes. A study was carried out of the effect of (a) a 20 p.p.m. addition of 'active' polymer, and (b) a 500 p.p.m. addition which had been degraded by stirring vigorously for 24 h, on the electrochemistry of the dissolution of iron. This investigation was split into two parts: a polarization study was made and then samples were electrochemically

Table 2. Effect of agitation of A33 solutions on flocculating times from electrolyte 2*

Time to settle to half-volume mark as fraction of water control	Fresh A33 added to concentration of 10 p.p.m.								
	Water only added	A33 added after 1 h stirred	A33 added after 4 h stirred	After 21 h stirred	After 45 h stirred	After 72 h stirred	After 102 h stirred	After 138 h stirred	
100%	2.9%	8.9%	33%	46%	58%	68%	84%	95%	

* Additive dissolved and aged in water. Ageing in 15% NaCl solution gave similar results.

factant had been aged for various periods by agitating with a laboratory stirrer.

3.3. Discussion

It will be seen from Fig. 6 that the anionic polyacrylamides, as well as the neutral N100 polymer, were all successful in rapidly flocculating the ECM dissolution product. Rates of separation seem to be slightly faster from electrolyte 2 than from electrolyte 1, 10 p.p.m. being required for the latter case whereas ~1 p.p.m. is sufficient for the former. The cationic polymers, polyethylene glycol and Polyox 30 were less effective flocculants. Degraded Decapol A33 had largely lost its flocculating power and presumably the other surfactants would behave similarly.

machined under industrial conditions and the dissolution efficiencies and surface finishes compared.

The polarization study was carried out on samples of 99.9% pure Fe in the form of a rotating disc electrode of 5 mm diameter. The current was measured after equilibrium had been established for each setting of anode potential. The potentials were referred to saturated calomel. The solutions used were 15% NaCl, 15% NaCl + 20 p.p.m. active A33, and 15% NaCl + 500 p.p.m. degraded A33. A rotation speed of 1000 r.p.m. was used, being more appropriate to real ECM conditions than a static solution.

The ECM experiments were carried out on mild steel samples held 0.5 mm from a copper cathode. The electrolyte, 15% NaCl or 15%

NaCl+20 p.p.m. active A33, was pumped through the cell in a turbulent manner (Reynolds Number ~ 2000) and metal dissolved for 30 s at a current density of $2.5 \times 10^5 \text{ Am}^{-2}$. The surfaces were studied optically and using a scanning electron microscope (SEM).

4.2. Results

4.2.1. *Polarization study.* It is seen from Fig. 7

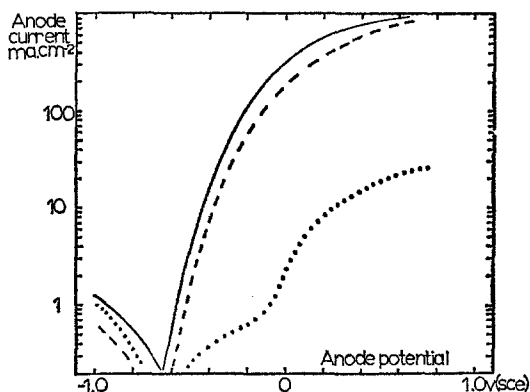

Fig. 7. Current voltage curves for iron:
 — In 15% NaCl solution.
 - - - - In 15% NaCl + 500 p.p.m. degraded A33.
 In 15% NaCl + 20 p.p.m. active A33.

that in 15% NaCl solution active dissolution of Fe occurs throughout the entire potential range down to -600 mV (SCE). The curve for the electrolyte with the addition of the degraded Decapol A33 is similar. However, it is seen that the 20 p.p.m. of active A33 inhibits the dissolution quite considerably, the anode being quite passive below zero (SCE). The dissolution current in this electrolyte fails to rise above 10% of that for NaCl alone right up to $+3.0 \text{ V}$ (SCE). On reversal of the potential very little hysteresis occurred, and the reproducibility of the polarization curves was always within a few per cent even at the lowest currents measured.

The effect of rotation speed is displayed in Fig. 8. For the pure NaCl solution to the limit of potential shown, no effect of rotation speed was observed. In the case of the NaCl + 20 p.p.m. A33 solution a slight decrease in current was observed with increase in rotation speed. This decrease was only small and may not be significant but it was highly reproducible.

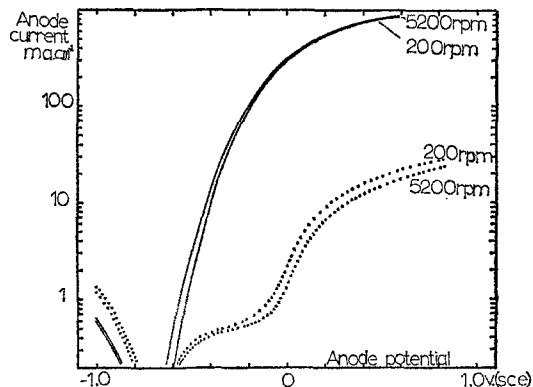

Fig. 8. Effect of rotation speed on the current/voltage curve of iron:

— 15% NaCl solution
 15% NaCl + 20 p.p.m. active A33

4.2.2. *Machining study.* The samples prepared in the electrolyte containing the Decapol appeared optically brighter than those prepared in pure NaCl, but to the touch were clearly rougher. The reasons for this may be seen in Fig. 9 and 10, which show SEM photographs of samples prepared in the two electrolytes. On a microscopic scale it is observed that in the NaCl, under the specified conditions, extensive crystallographic etching occurred. (This has been previously observed for the machining of steel in NaCl—see [8]). However, with the addition of the surface-active reagent and under identical conditions, polishing could be obtained. There was, though, a good deal of reaction product adhering to the surface, causing the samples to feel rough.

At intermediate concentrations the surface exhibited patches of crystallographic etching and of polishing. At higher concentrations of additive the amount of reaction product diminished until at 70 p.p.m. the surface shown in Fig. 11 was obtained. The grain boundaries stand proud of the surface.

The additive slightly reduced the efficiency of the dissolution. Assuming dissolution to the 2-valent state and the samples to be pure Fe, those samples dissolved in 15% NaCl dissolved with an efficiency of 99% whereas the dissolution in 15% NaCl + 20 p.p.m. A33 was only 92% efficient.

4.3. Discussion

The Decapols appear to be mixed ethylenic

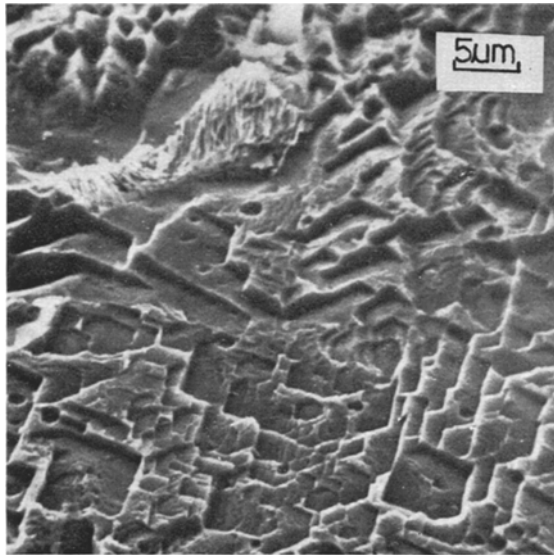

Fig. 9. Iron dissolved in 15% NaCl.

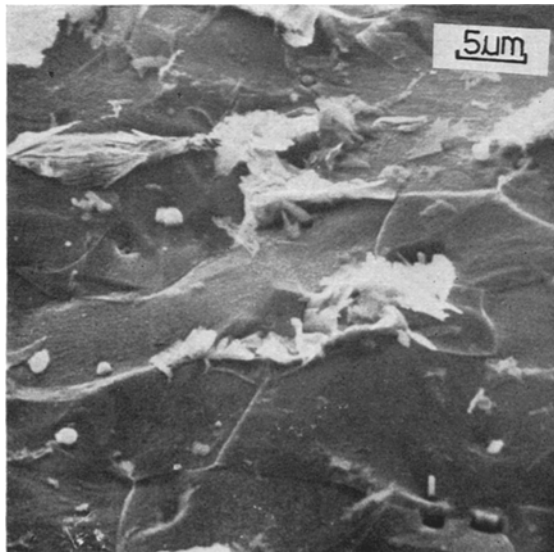

Fig. 10. Iron dissolved in 15% NaCl + 20 p.p.m. Decapol A33.

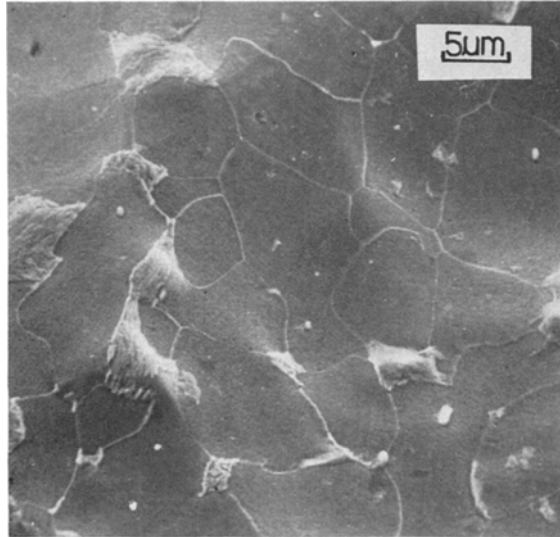
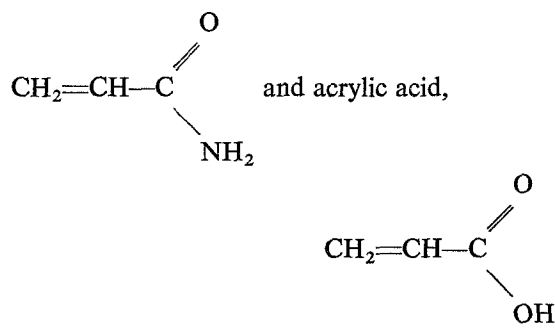
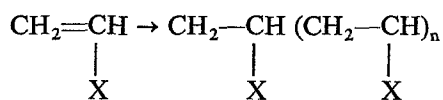

Fig. 11. Iron dissolved in 15% NaCl + 70 p.p.m. Decapol A33.

polymers. In the case of the 'A' series acrylamide,



polymerize thus:



where X represents a random distribution of either the acid amide group or the carboxylic acid group. Certainly the oxygen in the amide will be very electron-rich and will readily adsorb onto a metal surface [6]. Further, these chains are not likely to be geometrically straight and will intertwine and H-bond into bundles or micelles. It is probable that the degradation displayed is a result of the breakdown of this association rather than breakage of chemical bonds. The adsorption of the polymer markedly affects the dissolution kinetics of iron as shown in Figs. 7 and 8. The current-voltage curves for the electrolyte with active A33 show two distinct inhibition zones. Below -0.1 V (SCE) there is a constant current region; between -0.1 and $+0.1$ V there is a dissolution region; above 0.1 V the current again steadies out. No comparable discontinuities in the curves are observed for dissolution in pure NaCl and it seems that some competition for adsorption sites occurs between the H_2O (or Cl^-) and the carboxylic acid groups, and possibly also the amide groups.

After degradation the additive appears to have no effect on the kinetics. This is a rather mysterious occurrence but is supported by the behaviour in the flow work and in the flocculation work. If we assume that the three observations made, i.e. the effect on flow, the effect on flocculation and the effect on dissolution kinetics, are all symptoms of the same characteristic of the polymers, then support may be obtained for the association theory. The characteristic under

consideration is the ability of these materials to extensively associate one chain with another by H-bonding:

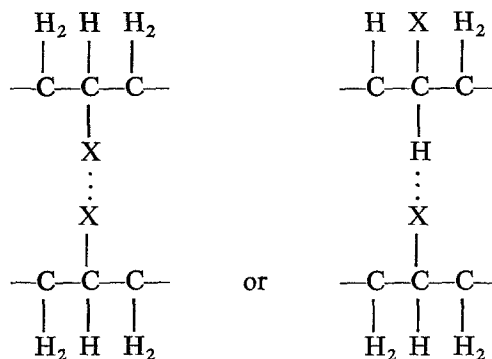

although clearly some association with the solvent will continue—possibly via the electron-deficient amine group.

If the associated complex then bonds to the metal, perhaps at only a single site, a very large area of organic associated complex is presented to the electrolyte and thus shields the metal from dissolution and serves to reduce drag. In the case of the A series polymers a large number of electron deficient amine groups are available to flocculate negatively-charged hydrated Fe_2O_3 particles. On the other hand a rupture of the H-bonds allows the polymer to interact fully with the solvent and this largely destroys its surface-active nature.

A certain amount of anode dissolution still occurs in spite of the adsorbed polymer. A possible effect of increased flow rate (rotation speed) is to cause the polymer to lie closer to the metal surface, possibly bonding at additional sites. In this way it covers more fully the surface and shows greater inhibition and a lower dissolution current.

The surface finishes shown in Figs. 9, 10 and 11 indicate that although surface-active additives inhibit the dissolution, improved surface finish might possibly be obtained as a result of their use.

5. Conclusion

The surface-active materials studied in this work were found to improve flow rates (up to 25%). The effect was found specifically for laminar flow conditions but not for turbulent flow under the conditions studied. Many of the materials were

also good as flocculants. However, the materials could be rapidly degraded by mechanical agitation after which the friction-reducing and flocculating properties disappeared; this was probably the reason for the low effect found under turbulent conditions. These phenomena might achieve practical use in ECM if a bleed system were devised to keep the surfactant at the optimum level. Related effects were observed in the electrochemical studies—the material studied (Decapol A33) adsorbed tenaciously in the active state, but showed no effect on the electrochemistry after degradation. This degradation has been explained in terms of a dis-association mechanism. A possible use of additives to ECM electrolytes is envisaged (a) to aid dissolution perhaps through some complex-forming mechanism, (b) to retard dissolution, although only to significantly do so in the areas of low-current density adjacent to the main machining zone (stray current areas) [7], (c) as established in the present work, to slightly retard dissolution by adsorption but to lead to a method of bringing about polishing in systems where it would otherwise not be possible. A further examination of the exact conditions under which an exten-

sively etched surface may become polished will need to be made. It will be necessary to determine if polishing occurs in stray current (low-current density) areas, and if it occurs for titanium alloys, nickel alloys and other difficult to machine materials.

Acknowledgements

The author thanks the Ministry of Defence for financial support.

References

- [1] P. J. Boden and P. A. Brook, *The Production Engineer* (1969) 408–17.
- [2] F. A. Lowenheim (Ed.), 'Modern Electroplating', John Wiley, New York (1963).
- [3] P. A. Brook and R. K. Flatt, *Inst. Electrical Engineer*, London, Publ. 61, p. 64.
- [4] G. E. Gadd, *Nature*, **212** (1966), 874.
- [5] G. E. Gadd, *Nature Phys. Sci.*, **230** (1971), 29.
- [6] I. G. Murgulescu and O. Radovici, 'First International Congress of Metallic Corrosion', Butterworth (1962).
- [7] P. J. Boden and J. M. Evans, *Electrochimica Acta* **16** (1971), 1071.
- [8] H. E. Freer, J. B. Hanley and G. D. S. MacLellan, 'Fundamentals of Electrochemical Machining', Ed. C. L. Faust, *Electrochem. Soc.* (1971).